

# TRACK LIGHT URBASA 25W

## Características

- Larga vida útil. Más de 50.000 horas
- Alta eficiencia lumínica
- Hasta un 80% de ahorro
- IP 20

## Aplicaciones

- Es adecuado para supermercados, tiendas especializadas, vitrinas, salas de exposiciones, donde la atención se centra en enfatizar puntos visuales especiales

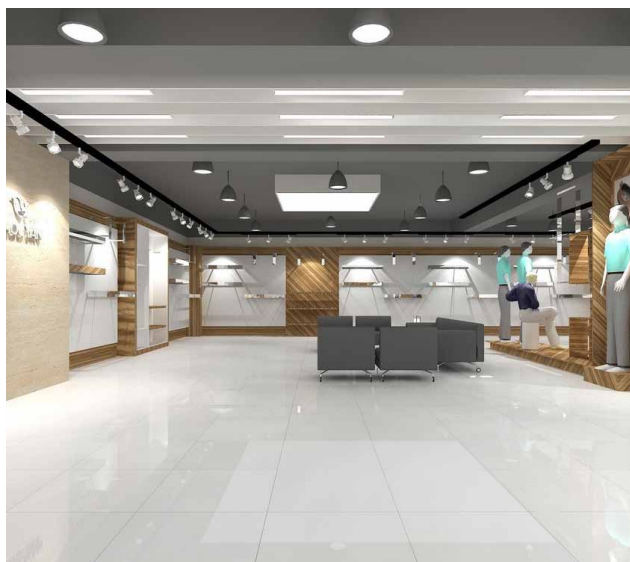

**Botón regulable**

## Especificaciones Técnicas del Producto

### No Regulable

CCT	2700K	3000K	4000K	5000K
LUMENES	2.150 Lm	2.375 Lm	2.450 Lm	2.600 Lm
POTENCIA	25W			
MODELO	URB-25W			
REGULABLE	No			
VOLTAJE	AC230V			
FRECUENCIA	50/60 Hz			
FACTOR DE POTENCIA	≥0.9			
CRI	≥80			
ÁNGULO DEL HAZ	15°/24°/36°			
CORRIENTE SALIDA	580 mA			
Tª FUNCIONAMIENTO	-20 ~45°C			
Tª ALMACENAMIENTO	-20 ~65°C			
IP	IP 20			
VIDA ÚTIL	50.000 horas			
DIMENSIONES	146*90*212mm			

### Regulable

CCT	2700K	3000K	4000K	5000K
LUMENES	2.150 Lm	2.200 Lm	2.400 Lm	2.450 Lm
POTENCIA	25W			
MODELO	URB-25W-D			
REGULABLE	Sí			
VOLTAJE	AC230V			
FRECUENCIA	50 Hz			
FACTOR DE POTENCIA	≥0.9			
CRI	≥80			
ÁNGULO DEL HAZ	15°/24°/36°			
CORRIENTE SALIDA	580 mA			
Tª FUNCIONAMIENTO	-20 ~45°C			
Tª ALMACENAMIENTO	-20 ~65°C			
IP	IP 20			
VIDA ÚTIL	50.000 horas			
DIMENSIONES	146*90*212mm			

## Dimensiones

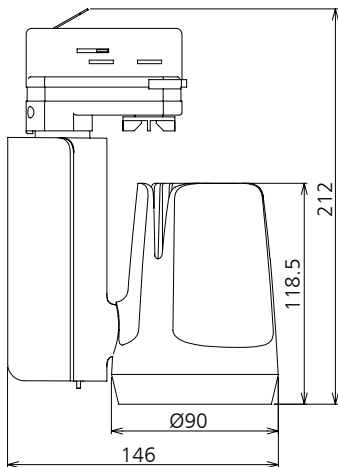

## Información Embalaje

CONTENIDO	MEDIDAS CARTON (cm) L*A*H	PESO BRUTO	PESO NETO
12 PC/CTN	53*39*41	9,5 kg	8,16 kg

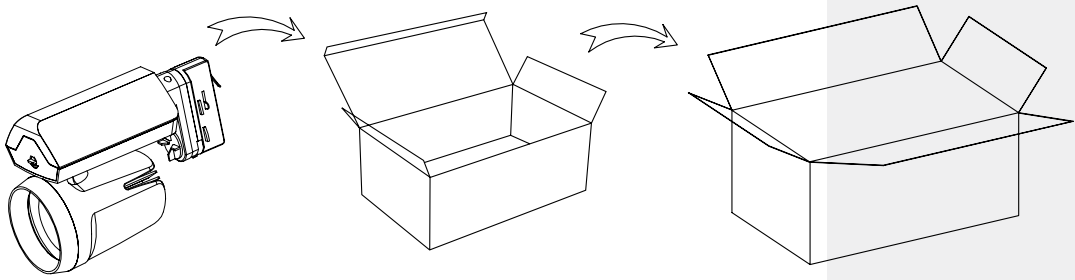

## Especificaciones Ópticas

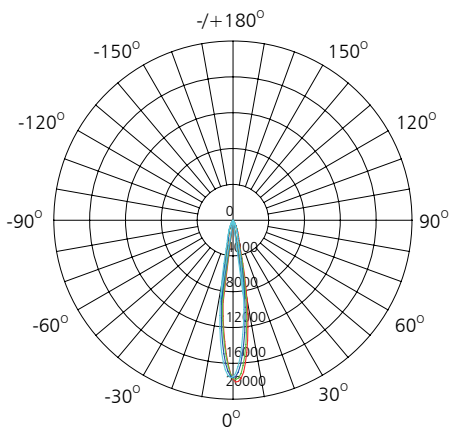

UNIT: cd

- C0/180, 17.2 deg
- C30/210, 17.1 deg
- C60/240, 17.1 deg
- C90/270, 17.1 deg

AVERAGE BEAM ANGLE (50%): 17.1DEG

# Especificaciones Ópticas

## 2700 K 3000 K

Distribución espectral



Diagrama de intensidad polar



Diagrama cartesiano de intensidad

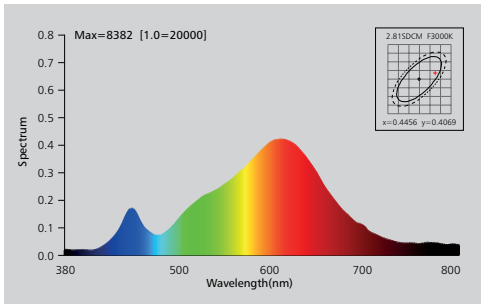
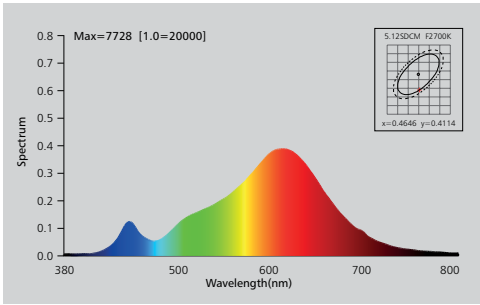

Diagrama de haz

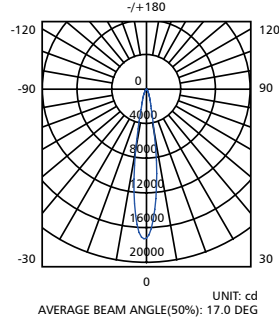
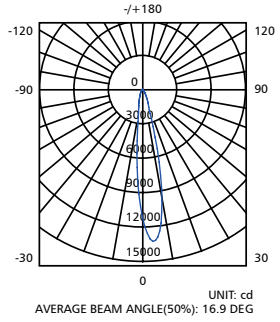

# Especificaciones Ópticas

## 4000 K

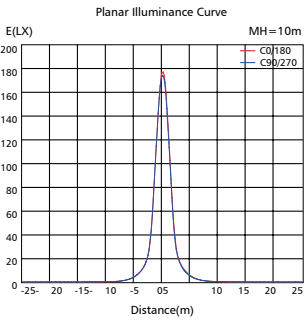
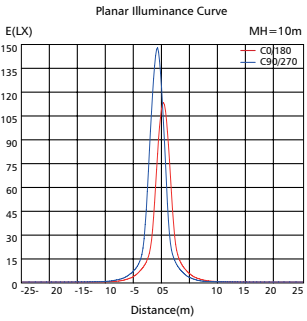
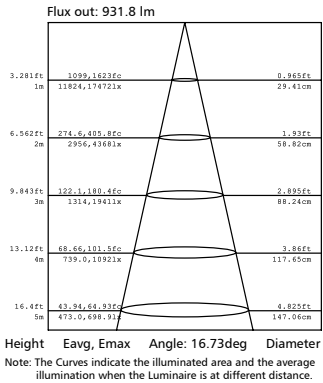
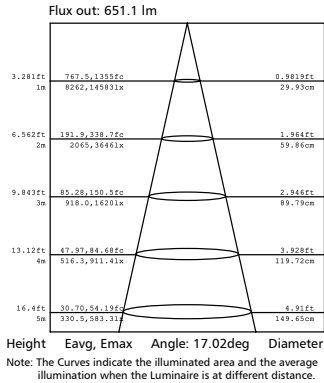
## 5000 K

Distribución espectral



Diagrama de intensidad polar



Diagrama cartesiano de intensidad

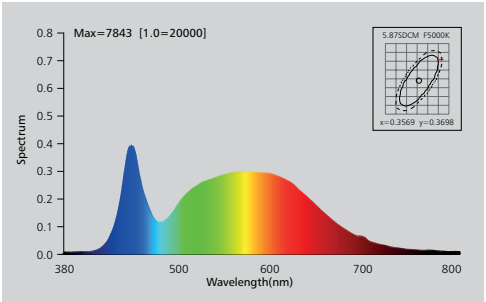
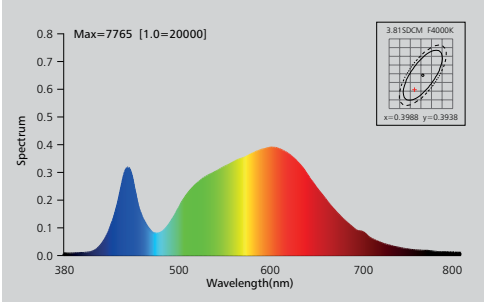

Diagrama de haz

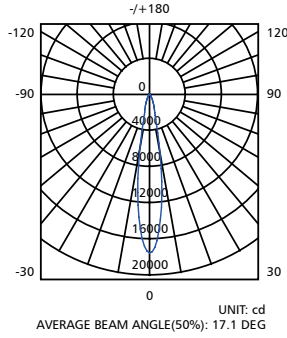
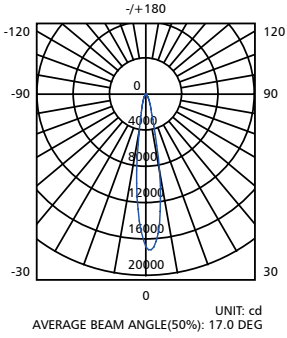

## Instalación

### **Paso 1**

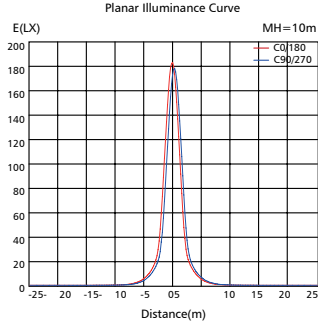
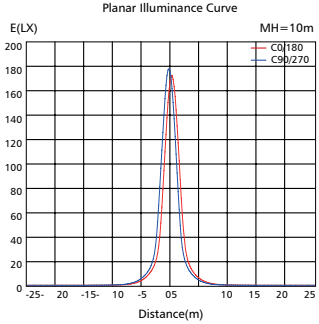
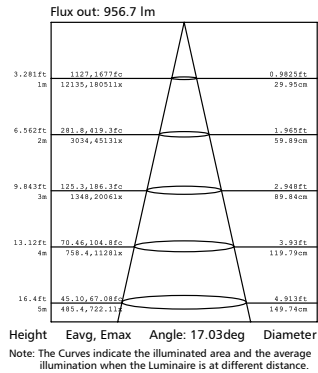
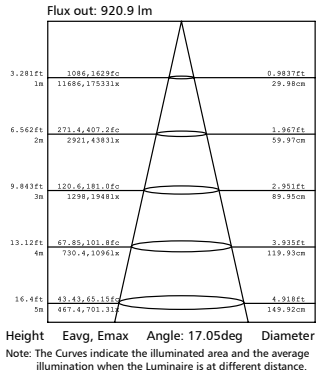
Apague la fuente de alimentación antes de comenzar cualquier instalación. Lea las instrucciones y compruebe que tiene todas las herramientas y accesorios para completar la instalación correctamente.

### **Paso 2**

Antes de colocar el adaptador en el carril, asegúrese de que esté en la posición DESCONECTADA y la Palanca de Bloqueo esté en la posición que se muestra.

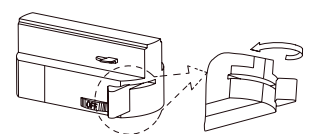

2 cables, adaptador de 3 cables

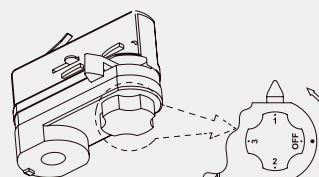

adaptador de 4 cables

### **Paso 3**

Coloque el adaptador de carril en el carril (1) y asegúrelo girando la palanca de bloqueo 90° (2)

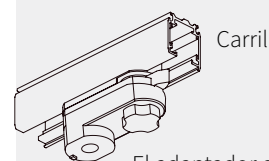
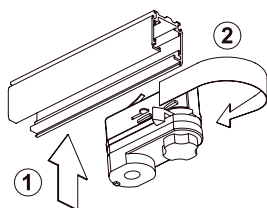

Carril

El adaptador de carril se muestra bloqueado en el carril

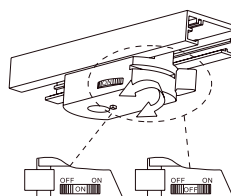

2 cables, 3 cables de control de luminarias en el mismo circuito con el interruptor de ENCENDIDO / APAGADO



4 cables  
Gire en sentido horario o antihorario

### **Paso 4**

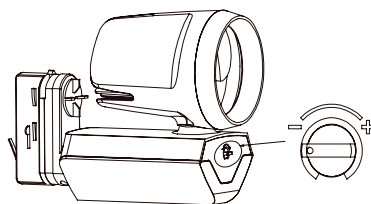

Botón Regulable

**POESSA, S.A.**

Avda. Cervantes, 35 - C.P. 48970 Basauri - Bizkaia (España)

Tel +84 94 671 30 00

[www.poessa.com](http://www.poessa.com)